

# AlcoQuant<sup>®</sup> 6020

---



Breathalyser  
Operating instructions



## Operating instructions

### Breathalyser AlcoQuant® 6020

These instructions have been prepared with the utmost care. If, however, you should find details that are not consistent when handling the system, please send us a brief comment to enable us to rectify the inconsistencies.

This is subject to modifications owing to further optical or technical developments that contrast to the data and illustrations contained in these operating instructions.

All trademarks quoted in the text and reproduced are trademarks of the respective proprietor and are acknowledged to be protected.

Reprints, translations and duplication in any form – including excerpts – require the written permission of the manufacturer.

This manual is subject to the alteration service of EnviteC- Wismar GmbH.

**Doc. no.: 059-07-21000300-h**

**© 2006 EnviteC- Wismar GmbH**

(Printed in Germany)

EnviteC- Wismar GmbH  
Alter Holzhafen 18  
23966 Wismar

Tel.: +49 - (0) 3841-360-1  
Fax: +49 - (0) 3841-360-222  
email: [info@envitec.com](mailto:info@envitec.com)

Internet: [www.envitec.com](http://www.envitec.com)

## CONTENTS

<b>1</b>	<b>GENERAL SAFETY AND SERVICE NOTES .....</b>	<b>5</b>
<b>2</b>	<b>DESCRIPTION OF DEVICE AND FUNCTIONS .....</b>	<b>6</b>
<b>3</b>	<b>APPLICATIONS AND PURPOSE .....</b>	<b>7</b>
<b>4</b>	<b>CONTROLS AND SYMBOLS .....</b>	<b>7</b>
4.1	THE DEVICE.....	7
4.2	SYMBOLS ON THE ALCOQUANT® 6020.....	8
<b>5</b>	<b>PREPARING FOR OPERATION .....</b>	<b>8</b>
5.1	HOW TO PREPARE NEW DEVICES.....	8
5.2	HOW TO PREPARE USED DEVICES.....	8
<b>6</b>	<b>HOW TO MEASURE IN THE ACTIVE OPERATING MODE .....</b>	<b>9</b>
6.1	HOW TO SWITCH ON THE ALCOQUANT® 6020.....	9
6.2	HOW TO PERFORM AN ACTIVE BREATHALYSATION PROCESS ON A TEST PERSON .....	10
6.2.1	<i>Test person: requirements.....</i>	10
6.2.2	<i>Measuring.....</i>	10
6.2.3	<i>Printing of measurement values .....</i>	12
6.2.4	<i>Further measurements .....</i>	12
6.3	HOW TO SWITCH OFF THE ALCOQUANT® 6020.....	12
6.4	POSSIBLE ERRORS IN THE CASE OF ACTIVE MEASUREMENT .....	13
6.4.1	<i>Blow failure .....</i>	13
6.4.2	<i>Flat battery.....</i>	13
<b>7</b>	<b>THE DATA MEMORY OF THE ALCOQUANT® 6020.....</b>	<b>14</b>
7.1.1	<i>Data memory overflow.....</i>	14
<b>8</b>	<b>AUXILIARY FUNCTIONS MENU .....</b>	<b>15</b>
8.1	PASSIVE MEASUREMENT MODE .....	17
8.2	LAST MEASURED VALUES .....	19
8.3	SETTINGS .....	20
8.3.1	<i>Time.....</i>	20
8.3.2	<i>Contrast.....</i>	21
8.3.3	<i>Units.....</i>	22
8.3.4	<i>Key tone.....</i>	23
8.3.5	<i>Languages .....</i>	23
8.4	HOUR COUNTER.....	24
<b>9</b>	<b>DEVICE CARE/CLEANING INSTRUCTIONS .....</b>	<b>25</b>
9.1	GENERAL CARE INSTRUCTIONS.....	25
9.2	ELECTRICAL CONTACTS .....	25
9.3	BATTERY CHANGE .....	25
9.3.1	<i>Battery charge indicator.....</i>	25
9.3.2	<i>How to change the batteries.....</i>	26
<b>10</b>	<b>CALIBRATION AND MAINTENANCE .....</b>	<b>27</b>
<b>11</b>	<b>ERROR DESCRIPTION AND RECTIFICATION .....</b>	<b>28</b>
<b>12</b>	<b>TECHNICAL SPECIFICATIONS .....</b>	<b>31</b>
<b>13</b>	<b>ORDER INFORMATION .....</b>	<b>33</b>
<b>14</b>	<b>WARRANTY .....</b>	<b>35</b>

## 1 General Safety and Service Notes

The law governing operational equipment (law governing technical safety) specifies that attention must be drawn to the following:

### **Please heed the operational instructions!**

Handling the device requires exact knowledge of these operating instructions and their observance. The device is intended for the application described only.



This symbol means: **WARNING**.

Warnings are indicated by the **WARNING** symbol shown on the left.



This symbol means: **ATTENTION**

Attentions alert the user to the care required for the AlcoQuant® 6020 to be safe and efficient.

#### Maintenance

Calibration and maintenance must be performed by authorised experts at six-monthly intervals (concluding in a report). It is recommended that a service contract should be concluded with an authorised service company. Maintenance work must be carried out on the device by authorised service personnel only. Only original parts from Evitec-Wismar GmbH may be used for repairs. Regarding this, please heed Section 10 "Calibration and Maintenance".

Six-monthly calibration of the device is necessary to guarantee the specified measuring accuracy (see specifications) over the entire period.

### **Do not operate in explosion hazardous areas!**

The device is not licensed for operation in explosion hazardous areas.

#### Environment:

Defective devices and empty batteries or accumulators should not be disposed of with domestic waste. They must be disposed of in accordance with the relevant national or regional regulations.

The electrochemical sensor used in the device contains hazardous substances and must be disposed of as stipulated in the EC directive 91/55/EEC.

## 2 Description of device and functions

The AlcoQuant® 6020 is a modern breathalyser for determining the alcohol level in the expiration air (lung air). State-of-the-art technologies for the prevention of faulty measurements and to ensure maximum measuring precision are implemented in the device. To achieve this, the following functions and components are constantly controlled.

- Device temperature
- Sample collection
- Signal generator
- LEDs
- Battery
- Alcohol sensor
- internal memory
- Calibration intervals

These are checked prior to measuring by means of an integrated micro-controller block and the relevant analysis software.

The AlcoQuant® 6020 contains a special **electrochemical sensor**, which reacts only to alcohol. The unique characteristic of this sensor is its specific reaction to alcohol as well as its long-term stability, facilitating a 6-monthly calibration interval. The influence of other substances that may be contained in the expiration air, such as acetone, eucalyptol, carbon dioxide, carbon monoxide (smokers) etc. is negligible owing to the electrochemical measuring principle applied.

The sample collection system, which has been developed for maximum precision, makes short measuring intervals possible, thus facilitating extremely short waiting periods between measurements. Thanks to the use of the new, improved ethanol sensor E 100 and the innovative sample collection system, a high degree of reproducibility of measuring results is guaranteed.

While a person is blowing into it, the device controls and determines the quantity of expired air. This ensures that the sensor receives only deep lung air which reflects the blood alcohol content correctly.

Another special feature of the AlcoQuant® 6020 is the short time required for it to become operational.

The intuitive operation of the AlcoQuant® 6020 is menu-controlled by means of three keys. All displays, device status and error messages appear in clear text on the illuminated graphic display. This makes the device self-explanatory and this in turn means that the user is informed of the current status of the device at all times during operation. This dispenses with the trouble of looking up and searching for the relevant error codes in the operating instructions.

The device is equipped with data memory and a serial PC interface. This makes it possible to printout and transfer measured data which can also be analysed statistically at a later time. The PC interface also enables the user to perform the entire maintenance, calibration and the device settings via a convenient PC program. Great store was set on extremely simple and user-friendly handling.

### 3 Applications and purpose

The AlcoQuant® 6020 has been developed for the fast and accurate determination of the alcohol level in a person's breath. Hence it is optimally suited for routine police checks.

### 4 Controls and symbols

#### 4.1 The device

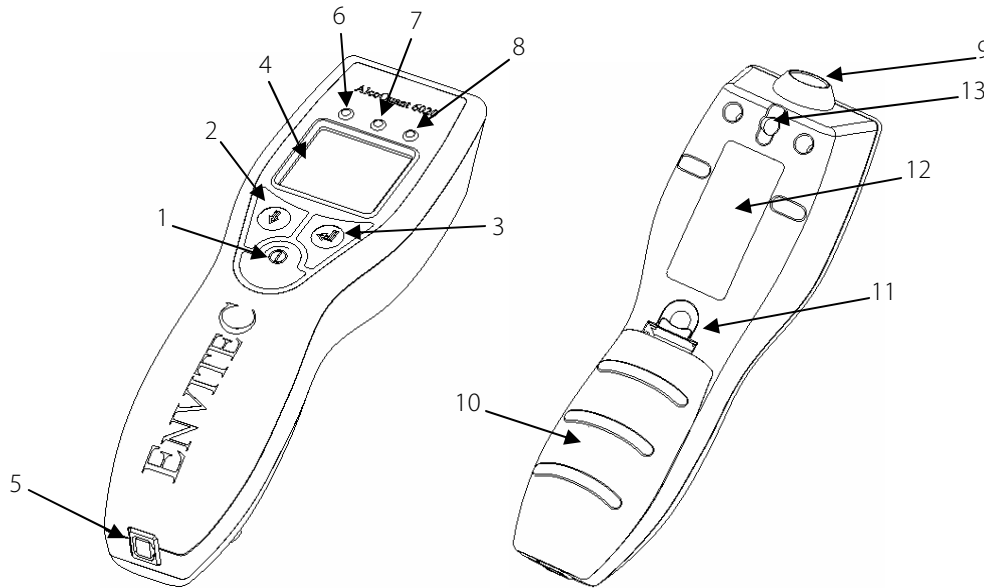





Fig. 1: Front view and rear view

No.	Assignment
1	ON/OFF keys
2	Select key
3	OK key
4	Display
5	RS 232 interface
6	Red LED: Error signal
7	Yellow LED: Measurement in progress / Attention
8	Green LED: Ready for measuring
9	Mouthpiece port
10	Battery compartment lid
11	Battery compartment opener
12	Device label
13	Expiration aperture

## 4.2 Symbols on the AlcoQuant® 6020

Symbol	Description
	Heed the operating instructions!
	Date of manufacture
<b>PN</b>	Product number
<b>SN</b>	Serial number
	Observe disposal regulations!

## 5 Preparing for operation

### 5.1 How to prepare new devices

The AlcoQuant® 6020 is installed, equipped and calibrated according to the requirements specified for it. It is supplied with 25 mouthpieces and 4 batteries (alkaline, R6/AA, 1.5V). The AlcoQuant® 6020 is therefore ready to operate.

### 5.2 How to prepare used devices

Prior to commissioning, check the calibration stickers on the device housing. If the date shown on the plate has been reached or exceeded, the AlcoQuant® 6020 must be recalibrated and/or sent for servicing and should not be used for measuring. Maintenance and calibration must be carried out by qualified and authorised personnel only.



## 6 How to measure in the active operating mode

Measuring in the active device operating mode serves to determine the precise alcohol level in the expired air. It is ensured that for this process only deep lung air is delivered to the sensor. This is necessary because the only clear correlation is between the alcohol content of deep lung air and the blood alcohol level.

### 6.1 How to switch on the AlcoQuant® 6020

The "ON/OFF" key ① must be pressed for approximately 1 sec. to switch on the AlcoQuant® 6020. The device switches on after one second and automatically performs a self test of the internal functions and components. During the self test phase the device version and the software version (Rev. x.x0) appear on the display for about 2 seconds:

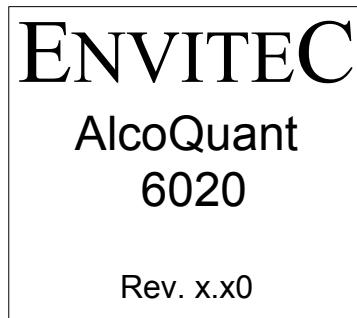

Display for about 2 seconds: the device self test is carried out and the next calibration date is displayed. All three LEDs light up briefly.



Display after about 3 seconds: The device is now ready to start measuring (green LED blinking at an interval of 1.5 seconds).



## 6.2 How to perform an active breathalysation process on a test person

### 6.2.1 Test person: requirements



#### Residual alcohol in the mouth

Residual alcohol in the mouth distorts the measurement. Hence it must be ensured that the test person has not consumed any alcohol immediately before measuring is carried out.

Waiting time: At least 15 minutes after the last alcohol was consumed.



#### ATTENTION:

Mouth sprays containing alcohol, medical syrups and drops can cause residual alcohol in the mouth, as can burping and vomiting. Rinsing the mouth with water or non-alcoholic beverages is no substitute for the waiting time!



#### Tobacco smoke

Tobacco smoke in the expiration air spoils or destroys the measuring system. Hence it must be ensured that the test person has not been smoking immediately before measuring is carried out.

Waiting time: At least 2 minutes after smoking.



#### Hyperventilation

Prior to measuring the test person should breathe normally and calmly and not repeatedly breathe in or out deeply because the breath alcohol level can be briefly reduced because the tidal air cools down, thus causing the measuring result to be distorted.

### 6.2.2 Measuring

#### How to insert the mouthpiece

The prepared original mouthpiece must be inserted into the mouthpiece port of the AlcoQuant® 6020 before measuring is performed. For this purpose the hygienic packaging of the mouth piece must first be removed.

#### Sample collection

During sample collection the test person must breathe into the device with a sufficiently large respiratory flow, evenly and without interruptions. Correct blowing is accompanied by a sequence of tones from the signal generator as well as the flashing yellow LED.



#### ATTENTION:

The expiration aperture must be kept free during the blowing-in process, otherwise the measured value is distorted.



#### ATTENTION:

The blowing-in process is finished when a tone is no longer to be heard. If the blowing-in process is interrupted before sample collection is completed, a long dual tone can be heard and an error message is displayed. The blowing-in process must be repeated.



During sample collection the following is displayed:

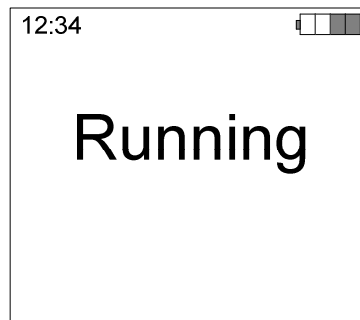

When sample collection has been completed successfully the alcohol level of the sample is analysed. The display shows the following message:

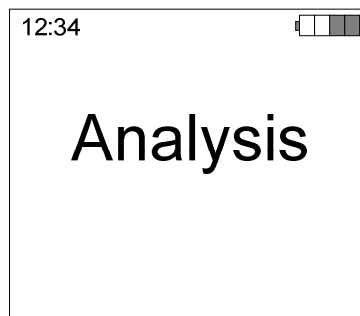

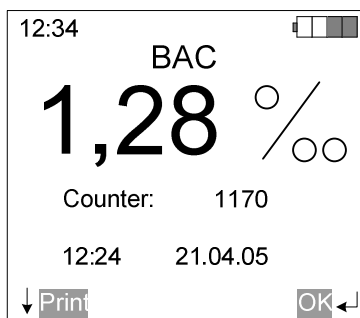

The time required for the analysis depends, among other things, on the alcohol level in the sample.

After the sample has been analysed, the result is displayed with the measurement number and date/time stamp:



The result of the current breathalysation is displayed until:

- The device is switched back to being ready for measuring by pressing the "OK" key  once, or
- The device is switched off by pressing the "ON/OFF"  key (3 sec.).

The measured value is always simultaneously stored in the memory.

After pressing "Print"-Button  a measurement report will be printed by an attached Printer (optional accessory).

If the measured value is above of the measurement range (0-5,5‰) the display shows the following message:

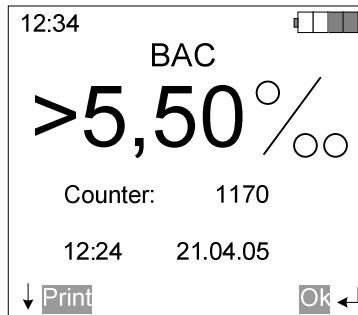

Additional it is signalled acoustically by a short dual signal and optically by the red LED.

### 6.2.3 Printing of measurement values

Press the "Print"-Button  while the measured value is shown (Section 6.2.2 and 8.1) a measurement report will be printed by an attached Printer (optional accessory).



#### ATTENTION:

After the „Print“-Button has been pressed the device not responds to any keypress for approx. 5sec. In this time the device sends the data to the connector.

### 6.2.4 Further measurements

After briefly pressing the "OK" key  the device is prepared for the next measurement and the sensor system is rinsed. Thereafter the procedure is the same as the sequence in Section 6.2.2.

## 6.3 How to switch off the AlcoQuant® 6020

The "ON/OFF" key  must be pressed for approximately 3 sec. to switch off the AlcoQuant® 6020. The device then switches off.

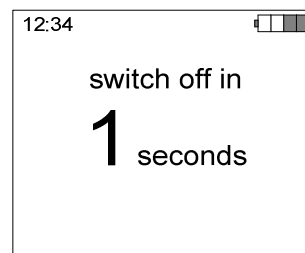
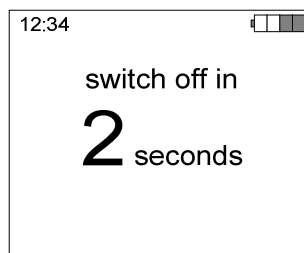
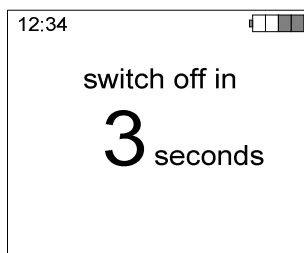

#### ATTENTION:

If no measuring procedure is carried out within 2.5 minutes of the device becoming ready to operate, the AlcoQuant® 6020 switches off automatically.



#### ATTENTION:

The background lighting of the display switches off automatically after 15 sec. and is reactivated by pressing any key. When the background lighting is switched off the first press of a key is used to switch the lighting on and does not affect the menu navigation.

---

## 6.4 Possible errors in the case of active measurement

### 6.4.1 Blow failure

If during sample collection the test person blows into the AlcoQuant® 6020 too less or too strong ( $8\text{l/min} < \text{Flow} < 70\text{l/min}$ ) or not continuously, the measuring procedure is automatically terminated and the following error message is displayed:

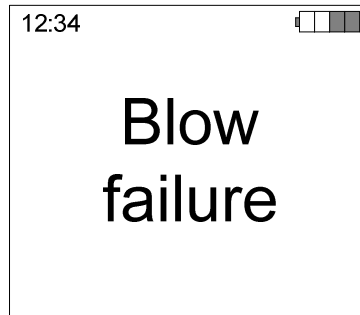

After this message the device automatically becomes ready to measure again (items in Section 6.2.2) and measuring can be repeated.

### 6.4.2 Flat battery

A repeated signal tone and the status display "Change battery" indicates that the batteries must be replaced. The device switches off after 10 seconds.

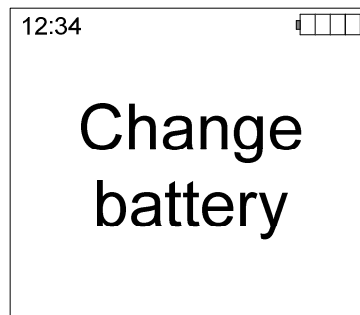

## 7 The data memory of the AlcoQuant® 6020

The device possesses a data memory into which the measuring results are logged. Each alcohol measurement performed is automatically stored with date, time, measured value and log number. The last 9999 data records are stored in the data memory.



### ATTENTION:

The measured values stored in the data memory are also retained when the batteries are modified.

### 7.1.1 Data memory overflow

The data memory can store up to 9999 measurements. Thereafter the oldest memory content is overwritten. This means that when the 10000<sup>th</sup> measurement is logged, the 1<sup>st</sup> measurement is overwritten.

When 90% of the memory capacity is reached (9000 measurements), the device gives a preliminary warning and the following message is displayed:

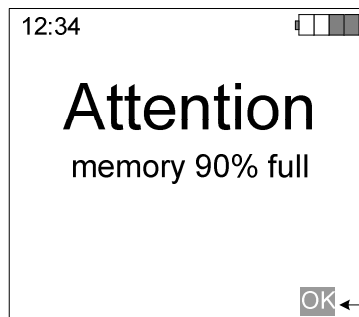

This preliminary warning must be acknowledged by pressing the "OK" key  once. After the 9999<sup>th</sup> measurement the following prompt appears:



This prompt must also be acknowledged by pressing the "OK" key  once.

Only then is the oldest measured value automatically overwritten with the new measured value!

## 8 Auxiliary functions menu

After it is switched on, the device automatically returns to the “active measurement mode”:



After the “Menu” key  has been pressed, the following menu options appear on the display:

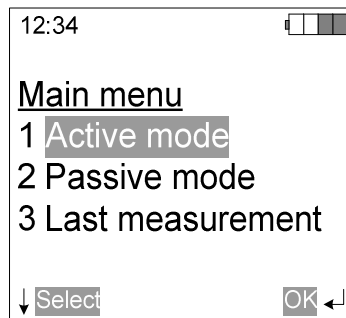

By pressing the “Select” key  again you can move to the next menu option:

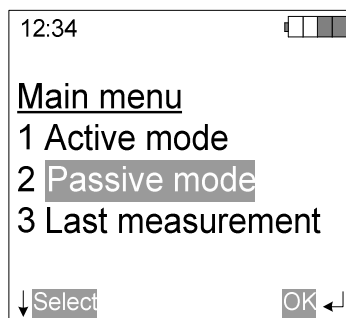

Consult Section 8.1. for how to select this auxiliary function.

By pressing the “Select” key  again you can move to the next menu option:

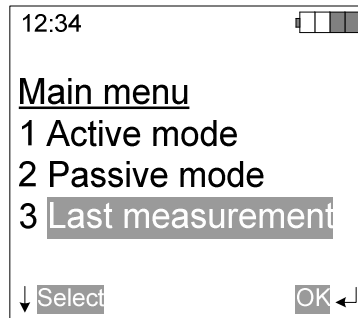

Consult Section 8.2. for how to select this auxiliary function.

By pressing the “Select” key  again you can move to the next menu option:

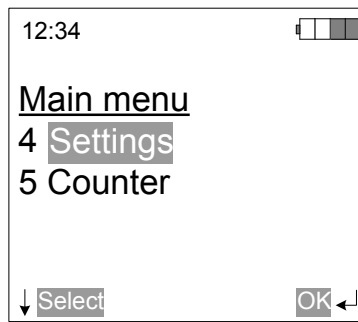

Consult Section 8.3. for how to select this auxiliary function.

By pressing the “Select” key  again you can move to the next menu option:

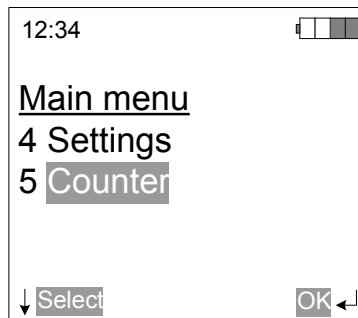

Consult Section 8.4. for how to select this auxiliary function.



**ATTENTION:**

If the “ON/OFF” key  is pressed briefly, you move to the 1<sup>st</sup> menu option, “Active measurement mode”.



## 8.1 Passive measurement mode

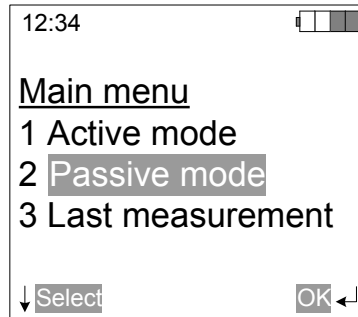

Measurement in the passive mode serves to check the ambient air for any alcohol content it may contain.

This does not mean that the precise value of the alcohol level of the breath is sought. It is only to check if there is any alcohol in the ambient air. Any values that vary from zero (0.00) are an indication that there is alcohol in the ambient air. The exact level of the alcohol in the breath must then be ascertained in the active device mode (Section 6).

After selecting the auxiliary function, "Passive measurement mode", the following content is shown on the display:

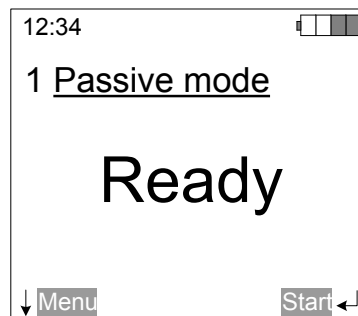

Passive measurement is carried out without a mouthpiece.

In this case the operator must hold the operational device close to the environment to be measured and then initiate sample collection by pressing the "Start" key  briefly once.

During sample collection the following is displayed:

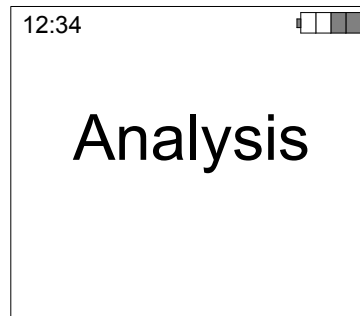

**ATTENTION:**

The time required for the analysis depends, among other things, on the alcohol content of the sample.

After the sample has been analysed, the relevant result is displayed.

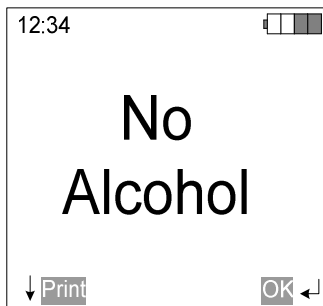

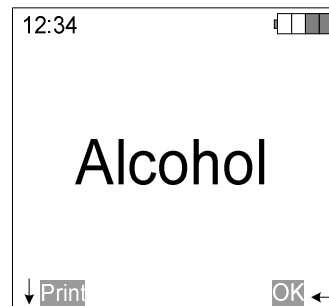

or



If no alcohol is detected, a signal sounds off and the green LED lights up.

If alcohol is displayed then a dual signal tone sounds (failure signal) and the red LED lights up.

The result of the current breathalysation is displayed until:

- The device is switched back to being ready for measuring by pressing the "OK" key  once, or
- The device is switched off by pressing the "ON/OFF"  key (3 sec.).

After pressing "Print"-Button  a measurement report will be printed by an attached Printer (optional accessory).



**ATTENTION:**

2.5 minutes after the last operating procedure an acoustic signal is given and the device switches itself off.

## 8.2 Last measured values

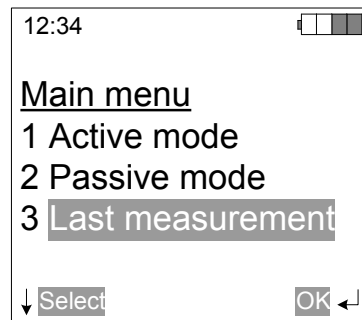

By using the auxiliary function "last measurement" all logged measured values can be displayed with date and time of the measurement as well as the log number.

After the "OK key"  has been pressed, the last value to have been measured appears on the display:

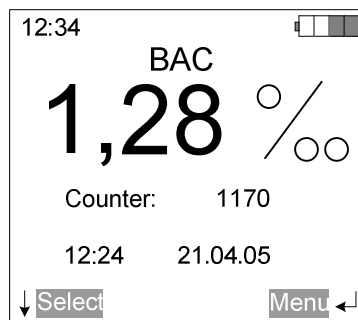

or (if the last measurement was passive):

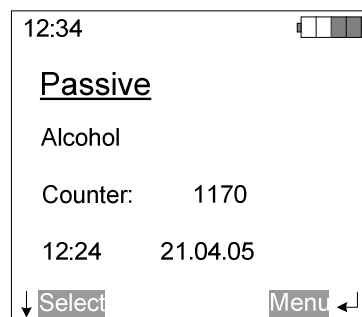

After the "OK" key  has been pressed, the previous value to have been measured appears on the display:

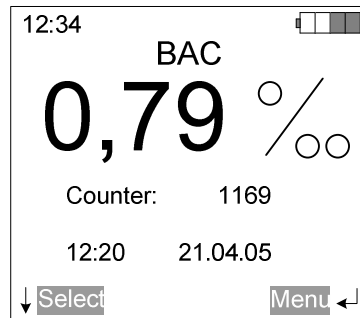

You return to the main menu by pressing the "Menu" key .

### 8.3 Settings

The "Settings" function is for changing various device settings.

After selecting the auxiliary function, "Settings", the following content is shown on the display:

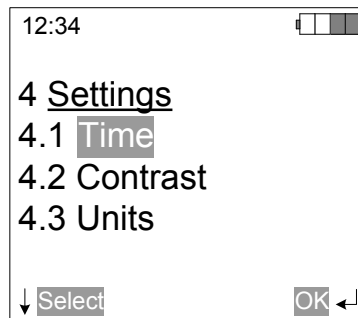

You move to the menu option by pressing the "OK" key .



#### ATTENTION:

If the "ON/OFF" key  is pressed briefly, you move to the main menu.

#### 8.3.1 Time

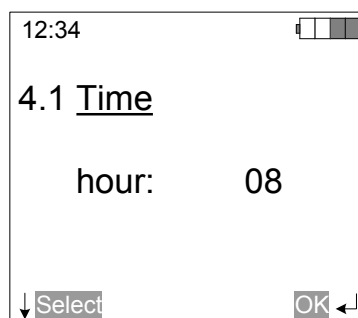

By pressing the "Select" key  the numbers of the hour can be modified.

By pressing the "OK" key  you move to the next menu option.

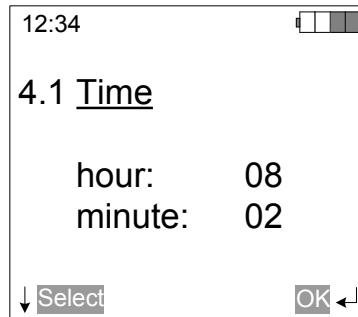

By pressing the "Select" key  the numbers of the minutes can be modified.

Press the "OK" key  to apply the settings and the device moves back to the menu option "Time".

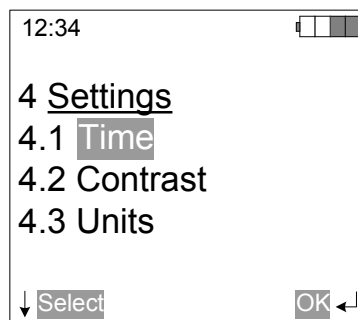

By pressing the "Select" key  you move to the next menu option.

### 8.3.2 Contrast

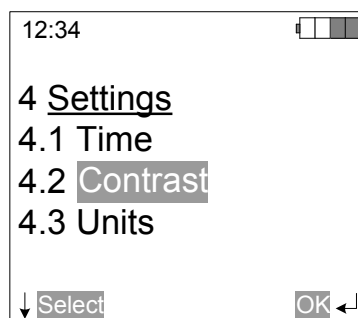

By pressing the "OK" key  you move to the menu option.

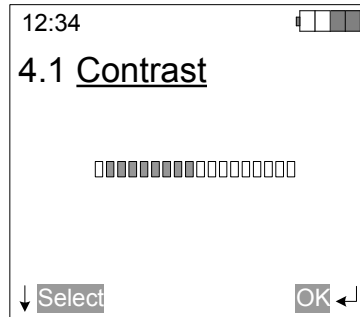



By pressing the “Select” key  the contrast can be modified.

After the “OK” key  has been pressed the settings are applied and the device moves back to the menu option “Contrast”.

By pressing the “Select” key  you move to the next menu option.

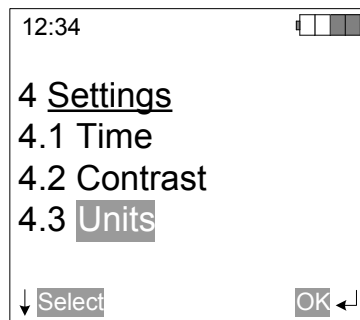
### 8.3.3 Units



By pressing the “OK” key  you move to the menu option.

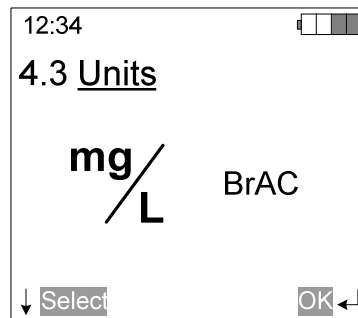
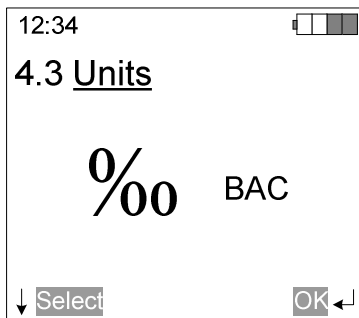

or

By pressing the “Select” key  the unit can be modified. All worldwide common units are configurable. The addition BAC/BrAC declare whether the unit describes the Blood- or Breathalcohol concentration (BAC = Blood Alcohol Concentration / BrAC = Breath Alcohol Concentration).

After the “OK” key  has been pressed the settings are applied and the device moves back to the menu option “Units”.





#### ATTENTION:

After modifying the unit the values in the memory are automatically displayed in the selected unit.

By pressing the “OK” key  you move to the next menu option.

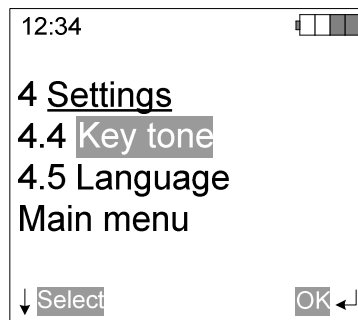
### 8.3.4 Key tone



By pressing the “OK” key  you move to the menu option.

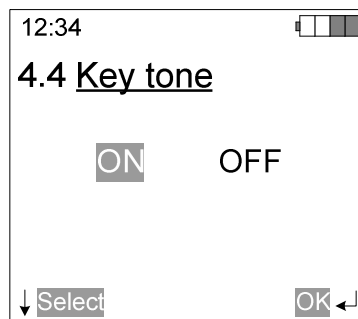

By pressing the “Select” key  the key tone can be switched on or off.

After the “OK” key  has been pressed the settings are applied and the device moves back to the menu option “Key tone”.

By pressing the “Select” key  you move to the next menu option.

### 8.3.5 Languages

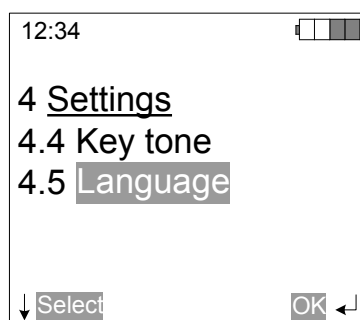

By pressing the “OK” key  you move to the menu option.

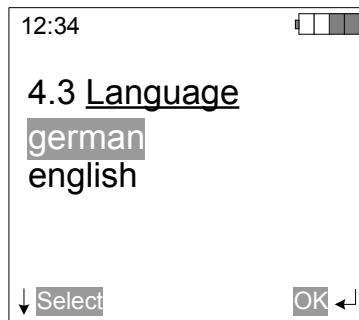

By pressing the “Select” key  you switch the language.

Press the “OK” key  to apply the settings and the device moves back to the menu option “Languages”.

#### 8.4 Hour counter

With the “Hour counter” auxiliary function you can display the operating hours and the number of the total measuring procedures.

After selecting the auxiliary function, “Hour counter”, the following content is shown on the display:

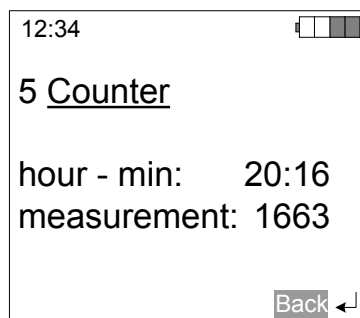

By pressing the “Back” key  you can move back to the menu option.



#### ATTENTION

If the “ON/OFF” key  is pressed briefly, you can move to the previous menu options.



## 9 Device care/Cleaning instructions

### 9.1 General care instructions

It is recommended that you use only mild cleaning agents to clean the device (preferably a cloth slightly moistened with water or washing up liquid generously diluted etc). Organic solvents such as pure alcohol, acetone, turpentine etc. should never be used for cleaning.

Care should be taken that no fluid penetrates the interior of the device. Special attention should be paid to the aperture of the port that holds the mouthpiece as well as the expiration apertures at the back of the device. The battery contacts and the serial interface must also be kept dry and clean.

### 9.2 Electrical contacts

Care must be taken that the electrical contacts inside the device (battery) and on the serial interface remain clean and dry to ensure that the device functions perfectly for many years.

### 9.3 Battery change

#### 9.3.1 Battery charge indicator

The AlcoQuant® 6020 displays the state of charge (SOC) of the batteries at all times.

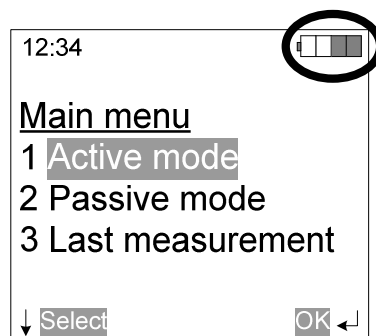

If the SOC of the batteries is too low the following is displayed:

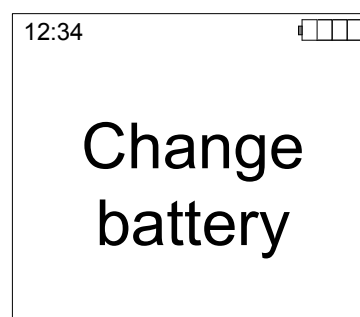

### 9.3.2 How to change the batteries

#### How to open the battery compartment

Gently press the battery cover lock and lift off the battery cover.



#### How to insert the batteries

The battery compartment takes 4 x R6 (AA) Mignon cells. When changing batteries, all four batteries must be changed at once. At this you have to attend the polarity of the cells. Thereafter the battery compartment is plugged back into the housing, in which the connectors are directed to the device as shown in the following picture. Afterwards close the battery cover.



## 10 Calibration and maintenance

The device must be calibrated every 6 months. This is necessary in order to ensure the specified measuring precision (see specifications) during that period of time.

Calibration can only be performed by authorised specialists or EnviteC Service. The equipment required for it (calibrator, flow meter, pump, service instructions, service software and calibration solution) can be ordered from EnviteC-Wismar GmbH.

The device should be serviced every 12 months. This includes the following measures:

Calibration: Calibration of the device

Testing: Test whether device functions are in proper working order

Maintenance: Measures to keep the device in perfect working order

Repair: Measures to restore the specified device function



**ATTENTION:**

Calibration and maintenance must be carried out by trained service personnel only. It is recommended that a service contract be concluded.

## 11 Error description and rectification

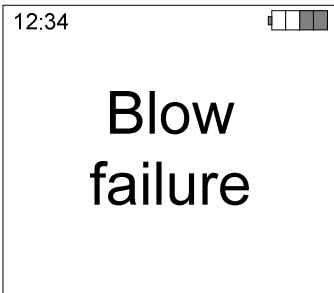
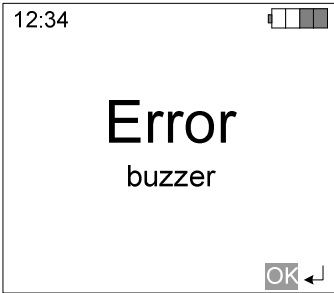
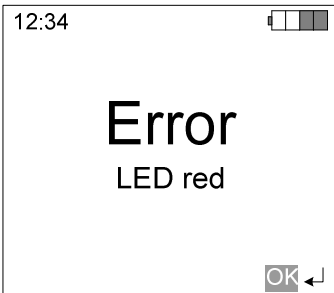
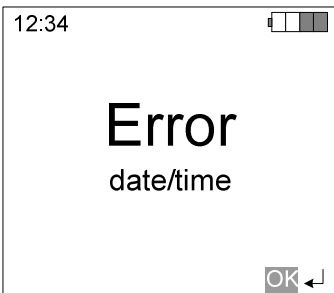
Error indication	Possible cause	Remedy
<b>User error</b>		
	<p><b>Blow failure</b></p> <p>This error appears if during the blowing-in process the respiratory flow drops below the required level before the blowing volume of at least 1.2L was reached.</p>	<p>After the failure is output (approx. 2 seconds), the device switches back to the previous measuring mode.</p> <p>A signal tone and the flashing green LED blinking at an interval of 1.5 seconds signalise that the device is ready for measuring.</p> <p><b>The blowing process can be restarted. The test person should blow longer and harder than before.</b></p>
<b>Device errors which do not endanger the measuring process (yellow LED)</b>		
	<p><b>Signal generator</b></p> <p>A defective signal generator has been detected.</p>	<p>Measuring is still possible</p> <p>The error message is only output during the self test (while the device is being switched on)</p> <p>If the error recurs, please inform Service.</p>
	<p><b>Error red LED (green, yellow)</b></p> <p>A defective, or only weakly-lit LED was detected.</p>	<p>Measuring is still possible</p> <p>The error message is only output during the self test (while the device is being switched on)</p> <p>If the error recurs, please inform Service.</p>
	<p><b>Time</b></p> <p>An error was detected while the current date/time was being determined.</p>	<p>Measuring is still possible</p> <p>The correct date/time may not be displayed. If this is the case, incorrect date, time values will be stored to memory with the current measured value.</p> <p>If the error recurs, please inform Service.</p>

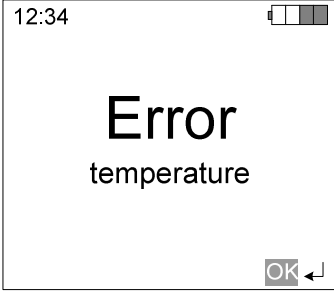
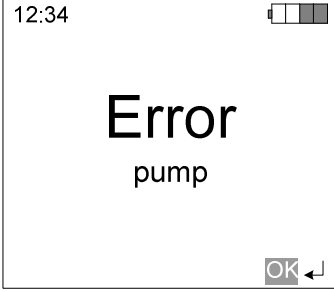
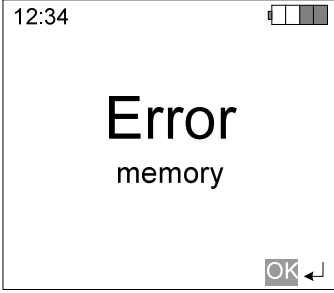
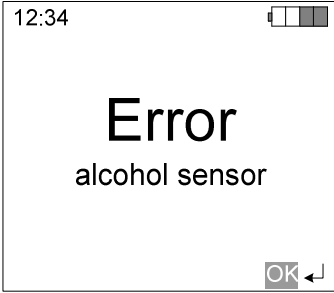
Error display	Possible cause	Remedy
<b>Device errors which endanger the measuring process (red LED)</b>		
	<p><b>Temperature</b></p> <p>The temperature established in the device is beyond the specified range of between -5 and +50°C.</p>	<p>Measurement may be faulty.</p> <p>Beyond the specified temperature range the measured values established may be subject to greater error tolerance than specified.</p> <p>The device must be switched off and brought to within the specified temperature range (by cooling or heating). Then the device must be switched on again.</p> <p>If the error occurs although the device is evidently within the specified temperature range, please inform Service.</p>
	<p><b>Sampling system</b></p> <p>An error was detected in the sampling system</p>	<p>The measured value may be faulty.</p> <p>Measure again.</p> <p>If the error recurs, please inform Service.</p>
	<p><b>Memory</b></p> <p>An error has occurred during reading or writing access to the internal memory.</p>	<p>Measuring is not possible.</p> <p>The measured value may not be displayed correctly.</p> <p>Data cannot be read correctly off the memory and the established measured values cannot be logged.</p> <p>Measure again.</p> <p>If the error recurs, please inform Service.</p>
	<p><b>Alcohol sensor</b></p> <p>An error was detected on the alcohol sensor</p>	<p>Measuring is not possible.</p> <p>Switch the device off and then on again.</p> <p>If the error recurs, please inform Service.</p>

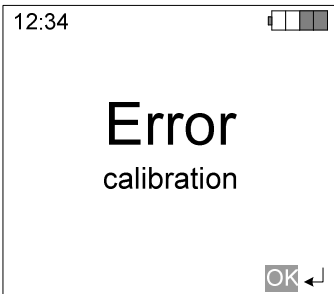
Error display	Possible cause	Remedy
	<p><b>Calibration</b></p> <p>An incorrect calibration date was found.</p>	<p>Measuring is not possible.</p> <p>Device must be calibrated again, please inform Service.</p> <p>If the device has already been calibrated, it is possible that the current date settings are not correct. Here, too, please inform Service.</p>

**ATTENTION:**

Each device error is signalled acoustically by a short dual signal and optically either by the yellow LED (error that does not impair measurement) or by the red LED (error impairing measurement). It leads to a corresponding error message on the display.

The error message must be acknowledged by pressing the "OK" key  briefly.

## 12 Technical Specifications

<p><b>Device:</b></p> <p>Measuring modes:</p> <p>Measuring range:</p> <p>Accuracy: Max. Measuring error, in relation to the ethanol standard:</p> <p>Range 0 to 1‰ Range 1 to 2‰ Range ≥ 2‰</p> <p>Standard deviation:</p> <p>Ambient conditions: Temperature range – operation: Temperature range – storage: Optimum storage temperature (sensor): Ambient pressure: Ambient humidity:</p> <p>Minimum expiration volume:</p> <p>Batteries:</p> <p>Number of measurements per battery pack:</p> <p>Device interface:</p> <p>Dimensions ( L x W x H):</p> <p>Weight:</p>	<p>Active and passive</p> <p>0 to 5.5 ‰ BAC</p> <p>± 0.05 ‰ absolute ± 5 % of measured value ± 10 % of measured value</p> <p>0,008‰</p> <p>-5°C to +50°C / +23F to +122F -20°C to +60°C / -4F to +140F 0°C to +25°C / +32F to +77F</p> <p>600 to 1400 hPa 20 to 98 % r.h.</p> <p>1.2 litres or depending on requirement</p> <p>4 x R6 (AA) Mignon cells</p> <p>more than 1600 tests, depending on the batteries and the ambient conditions</p> <p>RS 232 (serial interface). Data can be transferred to a PC or printer.</p> <p>190 mm x 61 mm x 38 mm</p> <p>275 g incl. Batteries</p>
<p><b>Miscellaneous:</b></p> <p>Ready to measure after switching on:</p> <p>Ready to measure after 0 ‰ measurement:</p> <p>Ready to measure after 1 ‰ measurement:</p> <p>Sensor type:</p> <p>Cross sensitivities:</p> <p>Mouthpiece holder:</p> <p>Mouthpieces:</p> <p>Units:</p>	<p>approx. 6 sec.</p> <p>approx. 2 sec.</p> <p>approx. 5 sec.</p> <p>E100 electrochemical measuring cell</p> <p>In the form of other substances accompanying respiration, such as acetone, CO etc., these are negligible.</p> <p>Depends on mouthpiece (type S or D)</p> <p>Disposable mouthpiece</p> <p>0Standard: mg/L, ‰; User-configurable on request: %, µg/100ml, µg/L, g/100ml, mg/100ml, PAF, PAWF, all units used worldwide and modes according to requirements</p>

---

Operation:	Menu-driven with clear text information
Input:	Three-key operation
Power-saving mode:	Device switches off automatically after 2.5 minutes of non-operation, the background lighting switches off after 15 seconds
Display:	Background illuminated, fully graphic
Data memory:	Stores 9999 measured values with date and time
Software:	Optional PC software for statistical analysis, data transfer and logging
Calibration:	Every 6 months
Subject to technical modifications!	



## 13 Order information

Order no.

<b>AlcoQuant® 6020 – Breathalyser, complete:</b>  Included in scope of supply: AlcoQuant® 6020, 4 batteries (alkaline, R6/AA, 1,5V), 25 mouthpieces, transport case and operating instructions <b>Customer-specific settings (e.g. unit, language etc.) by arrangement</b>	1000300
--	---------

### Accessories

Order no.

<b>Standard transport case:</b> Case with lining / 357 mm x 310 mm x 120 mm	1000644
<b>S type mouthpieces:</b> Mouthpieces with anti-rebreathing mechanism, 25 units, in individual hygienic packs	31-30-0022
<b>Printer:</b> Mobile matrix printer incl. battery with accessories comprising: printer, printer cable, mains charger and 1 roll of printing paper	1000616
<b>Printing paper:</b> 5 rolls of printing paper for printer	31-30-0026
<b>Ink ribbon for printer:</b> 1 ink ribbon for printer	31-30-0079
<b>Printer cable:</b> Printer cable for connecting device to printer	1000518
<b>"Data Manager 6020" software</b> PC software for analysing and documenting the measuring results of the AlcoQuant® 6020	1000520
<b>PC cable for the Data and Service Manager:</b> Data cable for connecting the AlcoQuant® 6020 to RS 232	1000519

### Accessories for service personnel:

Order no.

<b>Complete calibrator:</b> Calibrator for breathalysers with accessories comprising: calibrator with thermostat and circulating pump, flow meter (0-20 L/min), air supply (230 V AC / 50Hz Flow: 32 L/min), 2L calibration solution (1 ‰) and operating instructions	31-30-0123
<b>Calibrator:</b> Calibrator comprising: thermostat with circulating pump, calibration tank for 2L calibration solution, connectors, adapter, 2L calibration solution and operating instructions	31-30-0115
<b>Air supply to calibrator:</b> Pump 230 VAC / 50 Hz, max. flow 32L/min.	31-30-0034
<b>Flow meter:</b> Flow meter for 0 – 20L/min. with adjustment valve	31-30-0062

---

<b>Calibration solution 1 litre:</b> Standard ethanol solution corresponding to 1‰ blood alcohol level or 0.48 mg/L breath alcohol level	031-30-028
<b>Calibration solution 0.5 litre:</b> Standard ethanol solution corresponding to 1‰ blood alcohol level or 0.48 mg/L breath alcohol level	31-30-0053
<b>Calibration sticker:</b> 10 calibration stickers	31-30-0114
<b>"Service Software 6020"</b> EnviteC Service Training needed!	1000622
<b>Calibration key:</b> Calibration key for AlcoQuant 6020	1000537

Spare parts list and equipment for maintenance, service and repair of the device available upon request

## 14 Warranty

We give a 2-year warranty for defects caused by material or manufacturing faults from the date of purchase. Defects which come under the terms of the warranty are rectified in accordance with our terms of warranty. EnviteC gives no warranty if the operator jeopardises the functioning of the device by ignoring these operating instructions, by improper handling, or if the device is used for a purpose for which it was not intended or owing to outside intervention. In such cases, liability transfers to the operator!

The warranty expires if the device is affected by chemicals owing to leaking batteries or if batteries are used after their date of expiry.

The cost for transport to and from the place of repair for a measure that is not covered by the warranty shall be borne by the customer.

Please send devices to be repaired together with all accessories to the following address:

EnviteC-Wismar GmbH  
Alter Holzhafen 18  
23966 Wismar  
Germany



**ATTENTION:**

**Warranty coverage given only if the purchase receipt is presented!**

EnviteC- Wismar GmbH  
Alter Holzhafen 18  
23966 Wismar  
Germany

Tel.: +49 (0)3841 / 360-200  
Fax : +49 (0)3841 / 360-222

<http://www.envitec.com>

Document no: 059-07-21000300-h

06/06

© EnviteC